

# PLATE-M



## Ventilatore elicoidale a pannello con motore "UNEL MEC"

Plate mounted axial fans with "IEC" motor

### APPLICAZIONI

I ventilatori serie PLATE-M sono ideali per impieghi in cui necessitano consistenti portate d'aria e pressioni modeste, in applicazioni con fissaggio su parete o pannello. Ad esempio: ventilazione di stabilimenti, parcheggi, allevamenti, raffreddamento di apparecchiature elettriche, frigorifere ecc.

### GAMMA

La serie è costituita da 9 grandezze con diametro girante da 250 a 700 mm.

### PECULIARITÀ

La serie PLATE-M è caratterizzata da versatilità ed economicità, conseguenza dei materiali utilizzati e delle scelte progettuali: la girante prevede un robusto mozzo a morsa in fusione d'alluminio per il fissaggio delle pale, realizzate mediante stampaggio di diversi materiali, aventi sempre l'obiettivo di sopportare elevati carichi di lavoro.

Il motore è costruito seguendo standard internazionali garantendo così affidabilità ed a lungo termine un economico recupero del ventilatore semplicemente riparando o sostituendo il motore stesso.

### COSTRUZIONE

- Convogliatore a telaio quadrato con ampio raggio di aspirazione in materiale anticorrosivo o protetto contro gli agenti atmosferici.
- Rete portamotore ed antinfortunistica lato motore in filo d'acciaio e protetta contro gli agenti atmosferici, realizzata in conformità alla norma UNI EN 294.
- Girante ad alto rendimento con pale a profilo alare, ad angolo di calettamento variabile da fermo in tecnopolimero e mozzo in fusione d'alluminio. Equilibratura secondo norme UNI ISO 1940.
- Motore elettrico asincrono a corrente alternata trifase o monofase, protezione IP 55, isolamento classe F, servizio S1, forma B5, costruzione conforme alle norme IEC/EEC (UNEL-MEC).
- Esecuzione 5 (accoppiamento diretto con girante a sbalzo).

### SPECIFICHE TECNICHE

PLATE - M (versione standard)

- Aria convogliata: pulita o leggermente polverosa, non abrasiva.
- Temperatura aria convogliata: -20°C / +50°C.
- Tensione d'alimentazione:  
versione trifase (T) 400V-3Ph.  
versione monofase (M) 230V-1Ph.
- Frequenza: 50Hz.
- Flusso dell'aria da motore a girante, posizione A (FMG).

### ACCESSORI

- Serranda con chiusura a gravità (SG)
- Rete antinfortunistica lato girante (PG-P).  
(Necessaria nell'utilizzo a bocca libera)
- Distanziale (SP).
- Interruttore di servizio (SW).

### A RICHIESTA

- Versioni senza rete porta motore.
- Versioni con girante avente pale in fusione d'alluminio.
- Versioni ATEX (Plate M Atex)
- Versioni con flusso d'aria da girante a motore, posizione B (FGM).

### APPLICATIONS

PLATE-M line is designed for installations requiring large capacities with low pressures, in applications for wall or panel fixing. For instance: ventilation of commercial and industrial buildings, car parks, stock farms, cooling of electric and refrigerating equipments, etc.

### RANGE

This line consists of 9 sizes with impeller diameter from 250 up to 700 mm.

### ADVANTAGES

PLATE-M line is characterized by versatility and competitive prices, consequence of accurate design and material choices: impeller is composed of a sturdy hub in die-cast aluminum alloy and blades moulded in different materials suitable for heavy-duty applications. Motor is manufactured according to IEC standards, guarantying reliability and a long term economic recovery of the fan by replacing or repairing the motor itself.

### CONSTRUCTION

- Supporting frame with wide shaped inlet in corrosion proof material or protected against the atmospheric agents.
- Motor support and safety grid, in steel rod manufactured in accordance with UNI EN 294.
- Impeller with high efficiency airfoil blades in plastic material and hub in die cast aluminum alloy. Variable pitch angle in still position. Balancing according to UNI ISO 1940.
- Asynchronous electric motor three or single phase, protection IP 55, class F insulated, service S1, form B5, construction according to IEC / EEC (UNEL-MEC) standards.
- Arrangement 5 (impeller directly coupled to motor shaft).

### TECHNICAL SPECIFICATIONS

PLATE - M (standard version)

- Conveyed air: clean, not abrasive.
- Temperature of conveyed air: -20°C / +50°C.
- Voltage:  
Three-phase version (T) 400V-3Ph  
Single-phase version (M) 230V-1Ph
- Frequency: 50Hz
- Air flow from motor to impeller, position A (FMG).

### ACCESSORIES

- Shutter gravity (SG).
- Impeller side protection grid (PG-P).  
(Necessary for use in free air)
- Spacer (SP).
- Service switch (SW).

### ON REQUEST

- Versions without motor side grid.
- Versions with die-cast aluminum blades.
- Explosion proof versions (PLATE- Atex).
- Versions with air flow from impeller to motor, position B (FGM).

Le prestazioni indicate nei diagrammi si riferiscono ad aria alla temperatura di 15°C ed all'altitudine di 0 mt s.l.m. , e sono state ottenute in installazioni di tipo "B" in assenza di reti e accessori .  
 Performance shown in the selection diagrams refer to air at 15°C temperature and 0 mt a.s.l. altitude, and they were obtained in installation type "B" with no grid nor accessories.

2 poli/poles (3000 rpm) - trifase/three-phase (3Ph-400V 50Hz)

| Modello<br>Model | Portata - Flow rate<br>(m <sup>3</sup> /h) | Pm<br>(kW) | In max<br>(A) | Mot.<br>(H) | Lp<br>dB(A) |
|------------------|--|------------|---------------|-------------|-------------|
| 312 T            | 3.000                                      | 0,25       | 0,7           | 63          | 67          |

4 poli/poles (1500 rpm) - monofase/single-phase (1Ph-230V 50Hz)

| Modello<br>Model | Portata - Flow rate<br>(m <sup>3</sup> /h) | Pm<br>(kW) | In max<br>(A) | Mot.<br>(H) | Lp<br>dB(A) |
|------------------|--|------------|---------------|-------------|-------------|
| 254 M            | 1.400                                      | 0,04       | 0,5           | 56          | 47          |
| 314 M            | 2.300                                      | 0,09       | 1             | 56          | 50          |
| 354 M            | 3.200                                      | 0,12       | 1,1           | 63          | 54          |
| 404 M            | 4.800                                      | 0,18       | 1,6           | 63          | 59          |
| 454 M            | 6.300                                      | 0,25       | 2,4           | 71          | 65          |
| 504 M            | 9.000                                      | 0,55       | 4,5           | 80          | 66          |

4 poli/poles (1500 rpm) - trifase/three-phase (3Ph-400V 50Hz)

| Modello<br>Model | Portata - Flow rate<br>(m <sup>3</sup> /h) | Pm<br>(kW) | In max<br>(A) | Mot.<br>(H) | Lp<br>dB(A) |
|------------------|--|------------|---------------|-------------|-------------|
| 254 T            | 1.400                                      | 0,04       | 0,25          | 56          | 47          |
| 314 T            | 2.300                                      | 0,09       | 0,35          | 56          | 50          |
| 354 T            | 3.200                                      | 0,12       | 0,4           | 63          | 54          |
| 404 T            | 4.800                                      | 0,18       | 0,6           | 63          | 59          |
| 454 T            | 6.300                                      | 0,25       | 0,8           | 71          | 65          |
| 504 T            | 9.000                                      | 0,55       | 1,6           | 80          | 66          |
| 564 T            | 12.000                                     | 0,75       | 2             | 80          | 67          |
| 634 T            | 13.000                                     | 0,75       | 2             | 80          | 72          |
| 714 T            | 17.000                                     | 1,5        | 3,5           | 90L         | 76          |

6 poli/poles (1000 rpm) - trifase/three-phase (3Ph-400V 50Hz)

| Modello<br>Model | Portata - Flow rate<br>(m <sup>3</sup> /h) | Pm<br>(kW) | In max<br>(A) | Mot.<br>(H) | Lp<br>dB(A) |
|------------------|--|------------|---------------|-------------|-------------|
| 506 T            | 6.000                                      | 0,18       | 0,7           | 71          | 55          |
| 566 T            | 7.900                                      | 0,25       | 1             | 71          | 58          |
| 636 T            | 10.500                                     | 0,37       | 1,3           | 80          | 63          |
| 716 T            | 14.000                                     | 0,75       | 2             | 90S         | 65          |

8 poli/poles (750 rpm) - trifase/three-phase (3Ph-400V 50Hz)

| Modello<br>Model | Portata - Flow rate<br>(m <sup>3</sup> /h) | Pm<br>(kW) | In max<br>(A) | Mot.<br>(H) | Lp<br>dB(A) |
|------------------|--|------------|---------------|-------------|-------------|
| 508 T            | 4.500                                      | 0,08       | 0,6           | 71          | 48          |
| 568 T            | 6.000                                      | 0,12       | 0,7           | 71          | 52          |
| 638 T            | 8.000                                      | 0,18       | 0,8           | 80          | 57          |
| 718 T            | 11.000                                     | 0,25       | 1,1           | 80          | 58          |

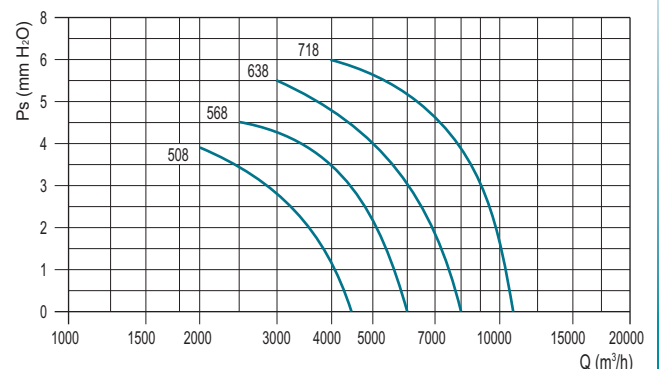
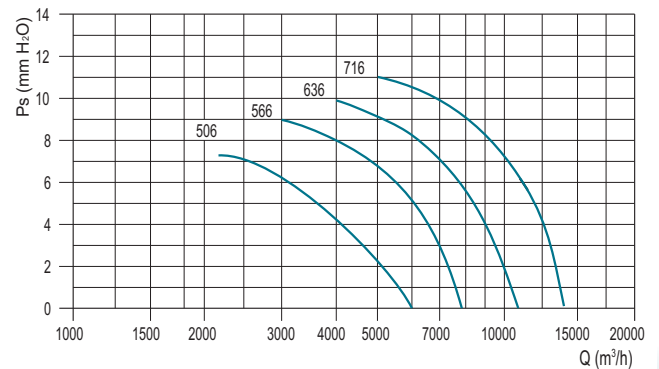
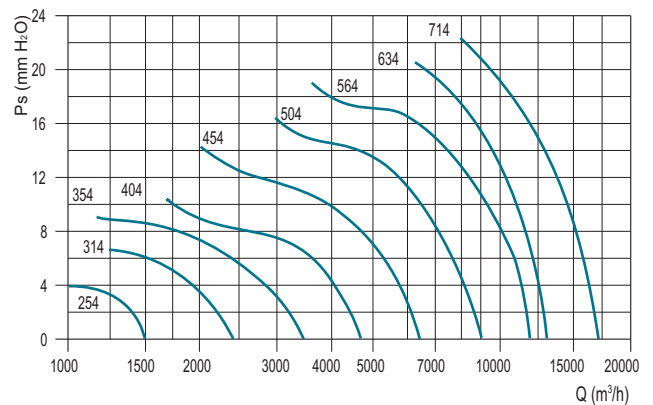
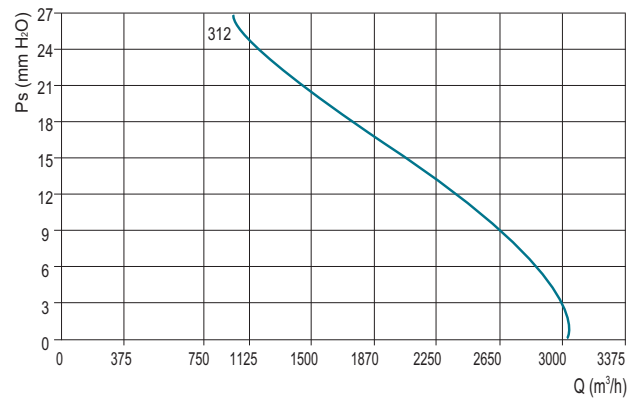

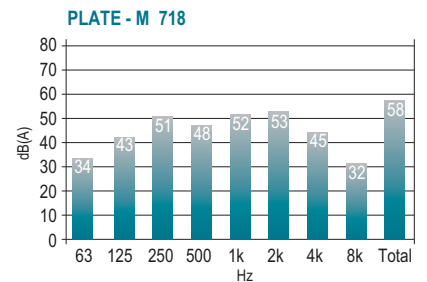
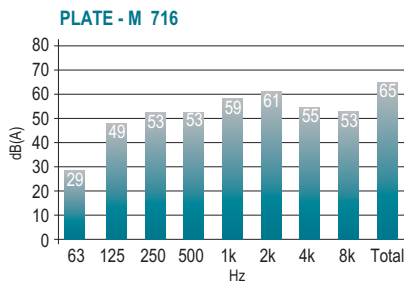
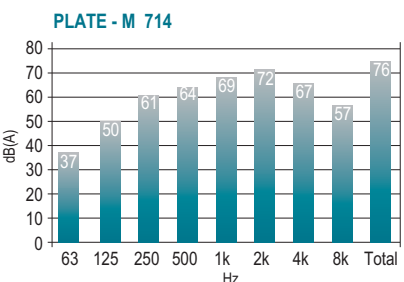
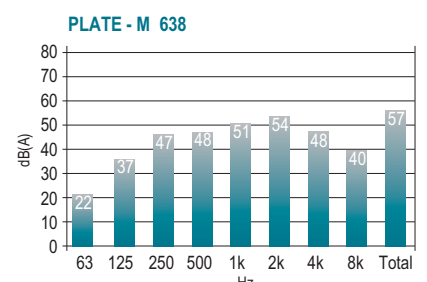
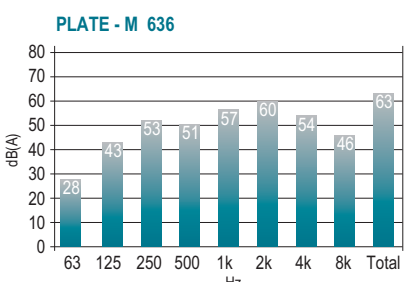
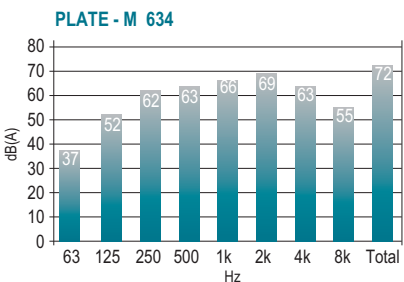
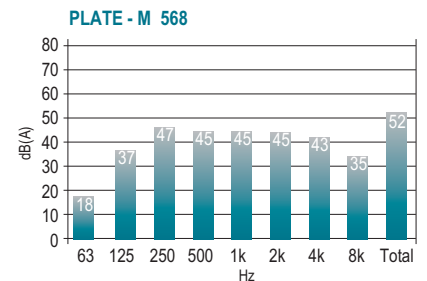
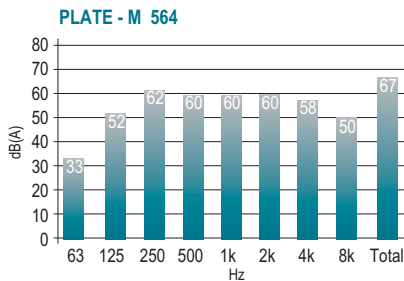
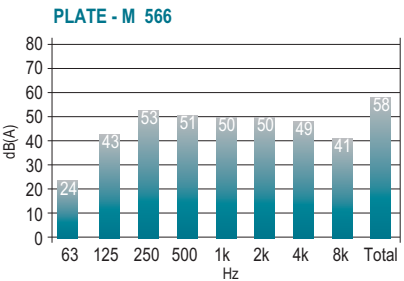
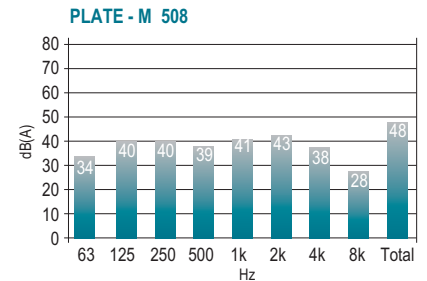
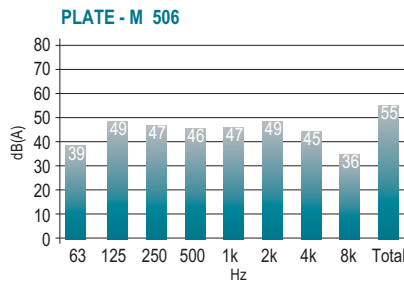
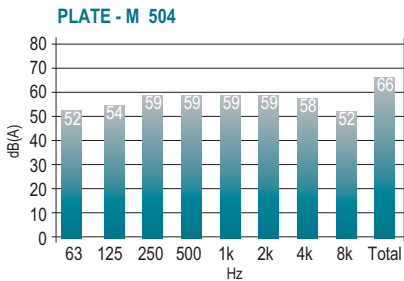
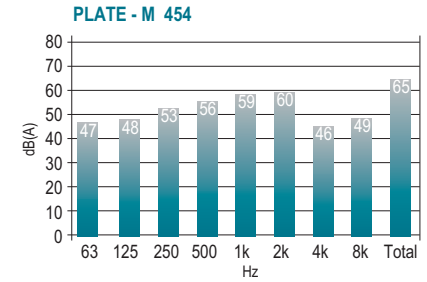
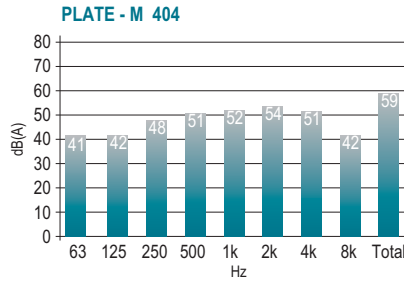
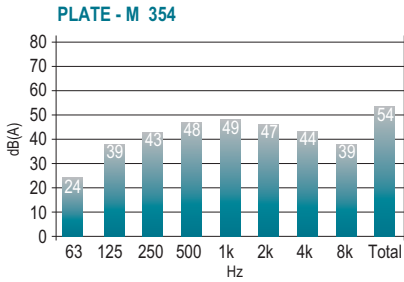
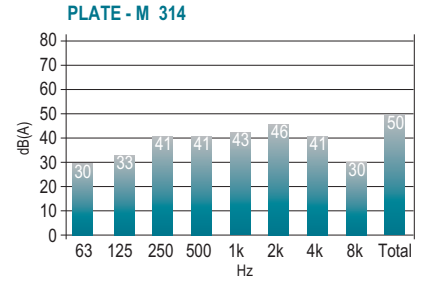
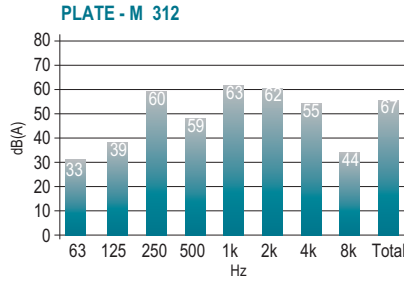
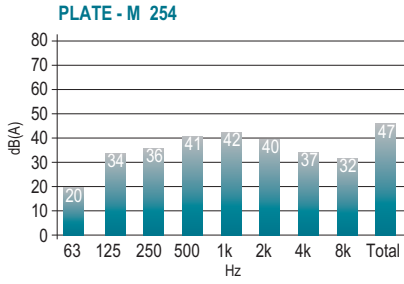

Attenzione: il livello di pressione sonora è riferito ad una misurazione onnidirezionale in campo libero a 3 m dal ventilatore con aspirazione e mandata libera.  
 Attention: sound pressure level is measured in free field at 3 m from the fan, in any direction, with free inlet and outlet

| Model | ØA  | BxB | CxC | ØD | E   | F(*) | ØG  | Kg(*) |
|-------|-----|-----|-----|----|-----|------|-----|-------|
| 25    | 260 | 340 | 300 | 10 | 90  | 270  | 315 | 6     |
| 31    | 310 | 390 | 350 | 10 | 110 | 320  | 365 | 7     |
| 35    | 360 | 440 | 400 | 10 | 110 | 320  | 410 | 8     |
| 40    | 410 | 500 | 450 | 10 | 110 | 320  | 465 | 9     |
| 45    | 460 | 560 | 510 | 10 | 110 | 340  | 510 | 13    |

| Model | ØA  | BxB | CxC | ØD | E   | F(*) | ØG  | Kg(*) |
|-------|-----|-----|-----|----|-----|------|-----|-------|
| 50    | 510 | 650 | 580 | 10 | 110 | 360  | 570 | 20    |
| 56    | 570 | 700 | 630 | 10 | 130 | 380  | 630 | 22    |
| 63    | 640 | 800 | 730 | 12 | 130 | 400  | 700 | 24    |
| 71    | 710 | 850 | 800 | 12 | 130 | 460  | 770 | 30    |

Dimensioni in mm/Dimensions in mm

(\*) Indicativo/Indicative

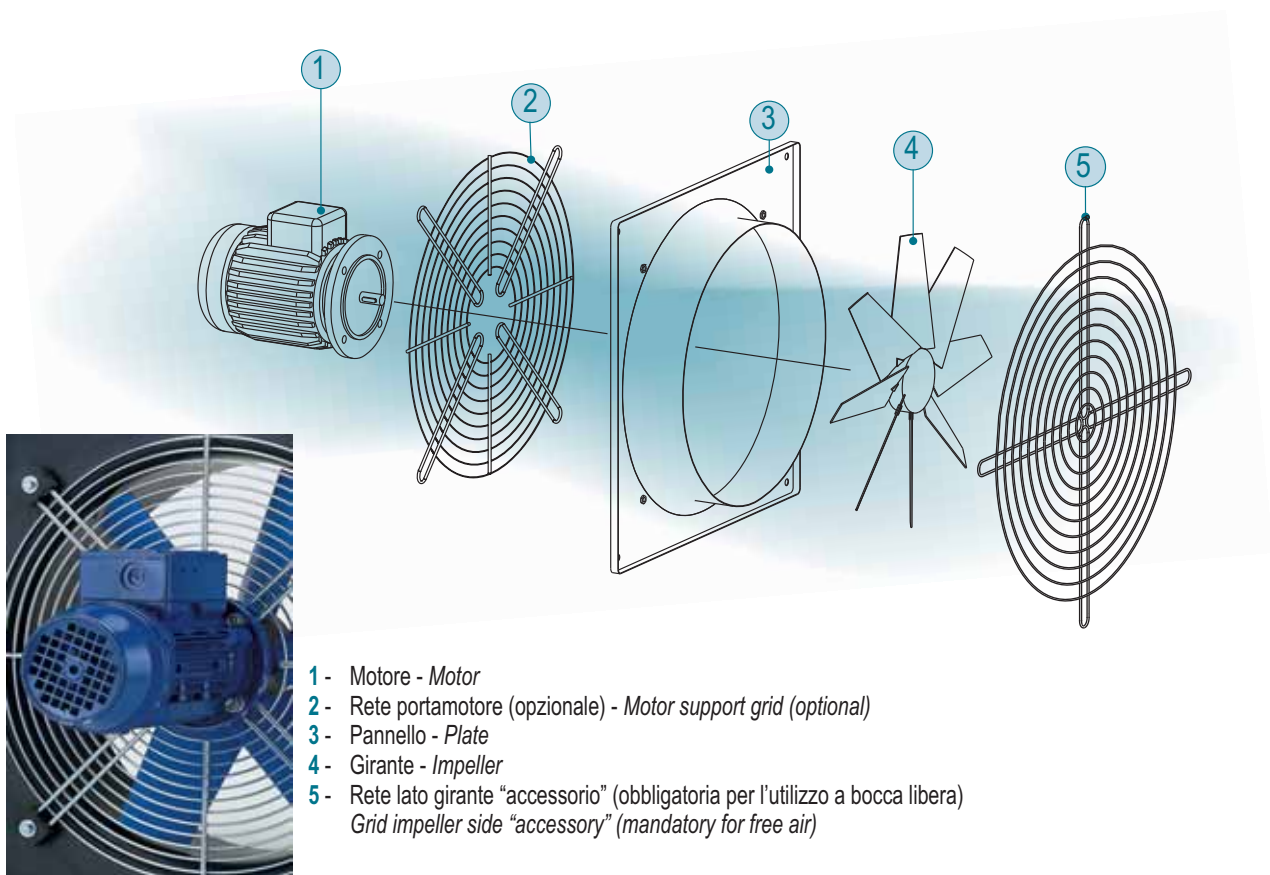
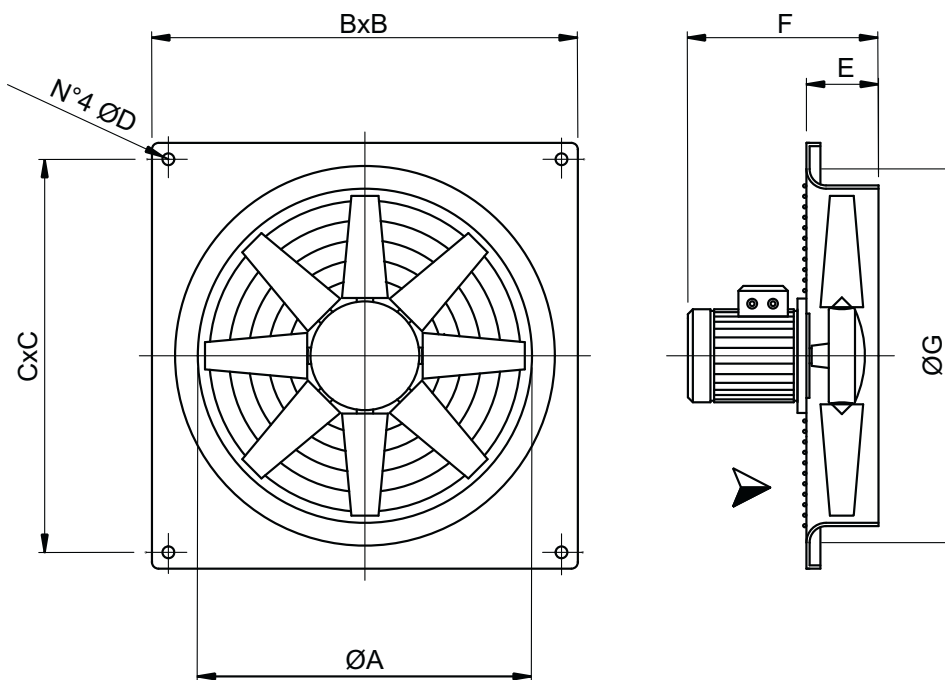

- 1 - Motore - Motor
- 2 - Rete portamotore (opzionale) - Motor support grid (optional)
- 3 - Pannello - Plate
- 4 - Girante - Impeller
- 5 - Rete lato girante "accessorio" (obbligatoria per l'utilizzo a bocca libera)  
Grid impeller side "accessory" (mandatory for free air)

**SERRANDA: SG**

Le alette della serranda si aprono con il movimento dell'aria a ventilatore acceso e si richiudono per gravità al suo spegnimento, evitando dispersioni di calore, l'entrata di pioggia, vento e volatili. Costruite interamente in materiale plastico.

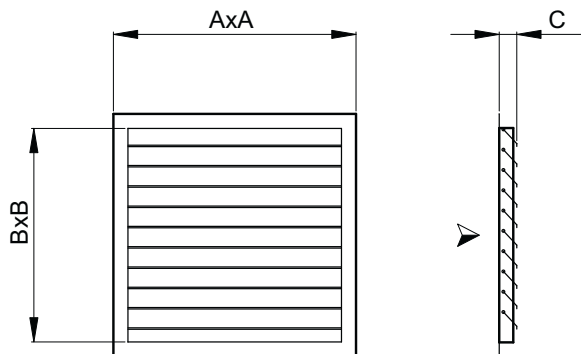
**GRAVITY SHUTTER: SG**

The fins of the shutter are opened by the air movement when the fan is operating and they shutdown by gravity when it is switched off, avoiding heat dispersions, the intrusion of rain, wind and birds. Completely made in plastic material.

| Model     | A   | B   | C  |
|-----------|-----|-----|----|
| SG 25- 31 | 370 | 300 | 35 |
| SG 35     | 440 | 370 | 35 |
| SG 40-45  | 510 | 440 | 35 |
| SG 50     | 580 | 510 | 35 |
| SG 56     | 650 | 580 | 35 |
| SG 63     | 720 | 650 | 35 |
| SG 71     | 785 | 715 | 35 |

**DISTANZIALE: SP**

Queste flange di distanziamento sono utilizzabili per poter fissare la serranda al ventilatore quando il muro o il pannello, su cui lo stesso si deve montare, hanno uno spessore inferiore alla profondità del boccaglio.

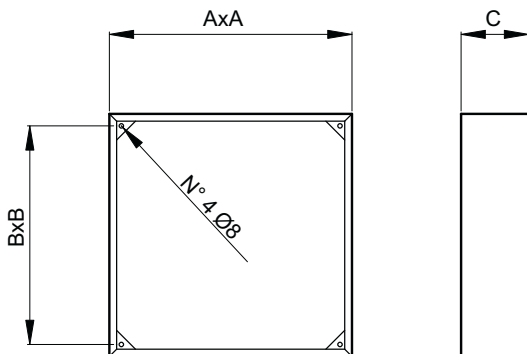
**SPACER: SP**

They are required to fix the shutter to the fan when the wall or the panel has a thickness lower than the height of the bell mouth of the fan

| Model | A   | B   | C   |
|-------|-----|-----|-----|
| SP 25 | 390 | 300 | 140 |
| SP 31 | 390 | 350 | 140 |
| SP 35 | 440 | 400 | 140 |
| SP 40 | 510 | 450 | 140 |
| SP 45 | 560 | 510 | 140 |
| SP 50 | 630 | 580 | 140 |
| SP 56 | 700 | 630 | 140 |
| SP 63 | 790 | 730 | 140 |
| SP 71 | 840 | 800 | 140 |

**RETE LATO GIRANTE: PG-P**

Serve ad evitare l'intrusione, dal lato girante, di volatili, roditori ed impedire il contatto accidentale con la girante in rotazione. Realizzata in filo d'acciaio elettrosaldato, nel rispetto della normativa antinfortunistica. (Necessaria nell'utilizzo a bocca libera)

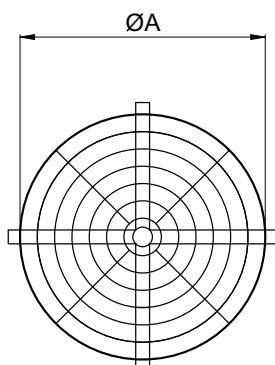
**IMPELLER SIDE PROTECTION GUARD: PG-P**

To be used to avoid the intrusion, from the impeller side, of birds or rats and to preserve from the casual contact with the rotating impeller. It is manufactured in steel rod according to the actual safety directive. (Necessary for use in free air)

| Model   | A   |
|---------|-----|
| PG-P 25 | 260 |
| PG-P 31 | 320 |
| PG-P 35 | 360 |
| PG-P 40 | 410 |
| PG-P 45 | 460 |
| PG-P 50 | 510 |
| PG-P 56 | 570 |
| PG-P 63 | 640 |
| PG-P 71 | 720 |